





Indico 

**Brazos de punto recto. Tres opciones de brazos: sin tensión / semi-tensión / con tensión.  
Especialmente diseñado para ventanas sin balcón, aunque puede ser aplicado en otras estructuras igualmente.  
Posibilidad de montaje con cofre NauticoN1 Premium y cofre DesertD1.**

*Curved Arms System. Three options for the arms: without tension / medium-tension / with tension.  
Although it might be especially designed for windows without balcony, it can be used in many other cases.  
Assembly option with Premium NauticoN1 box and DesertD1 box.*

*Bras courbés. Trois positions de bras: sans tension / semi-tension / avec tension.  
Spécialement conçu pour fenêtres sans balcon, mais également applicable sur d'autres structures.  
Possibilité de montage avec coffre NauticoN1 Premium et coffre DesertD1.*

*Braccia a caduta. Tre opzioni di braccia: senza tensione / con semi-tensione / con tensione.  
Progettate specificatamente per finestre e vetrine di negozi.  
Possibilità montaggio con cassonetto Nautico N1 Premium e cassonetto Desert D1.*

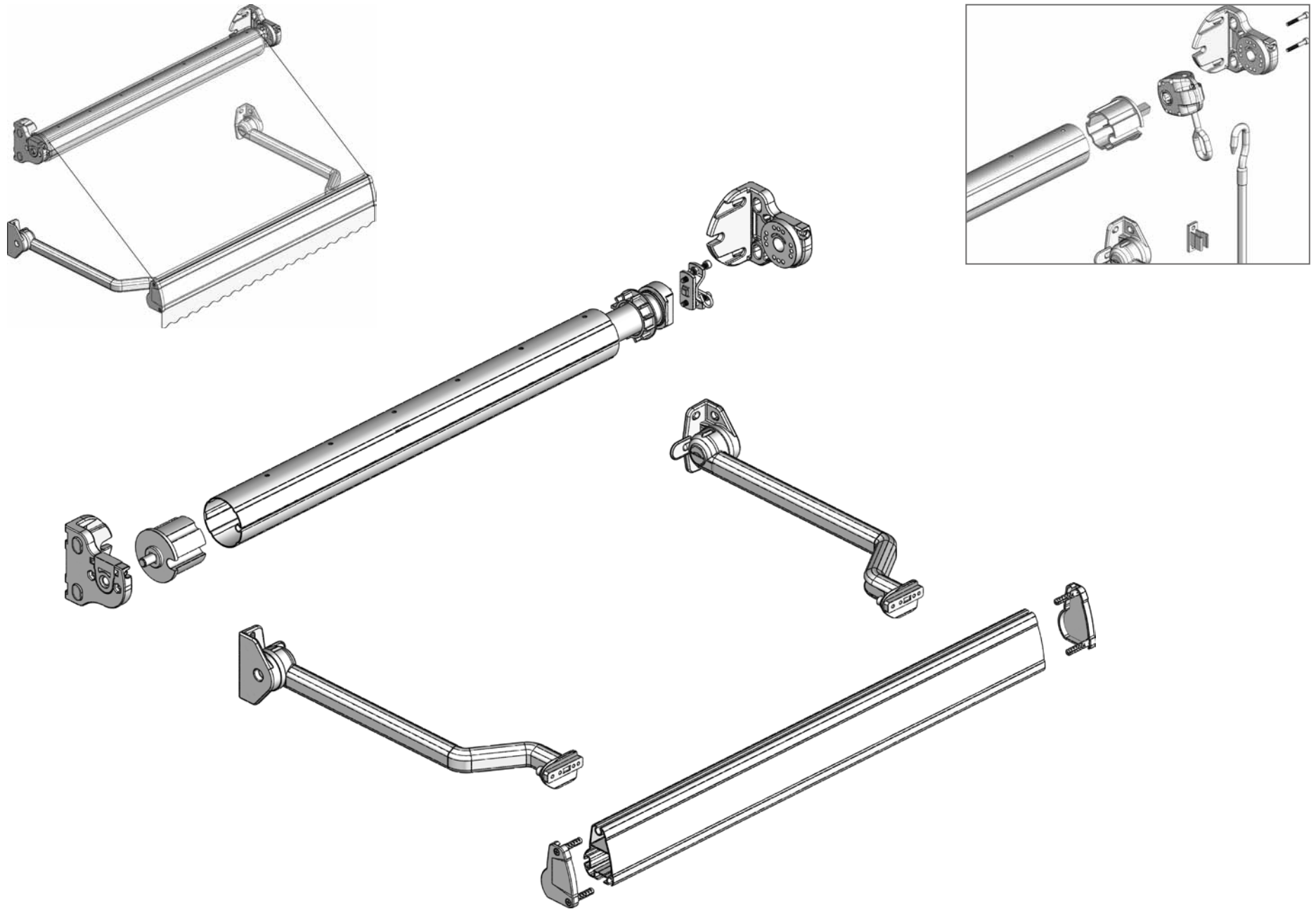

**Despiece sistema** / System parts / Système détaché / Esploso del sistema

**Ejemplo para montaje IndicoI2, 3,50 m x 1,20 m (Línea x Salida). Color blanco**  
*Assembly example for IndicoI2 with 3,50 m width and 1,20 m arms projection. White colour*  
*Exemple de montage IndicoI2, 3,50 m x 1,20 m (Largeur x Avancée). Couleur blanc*  
*Esempio di montaggio Sistema Indico I2, 3,50 m x 1,20 m braccio. Nel colore bianco*

**Ejemplo IndicoI2 motorizado / Example for IndicoI2 with motor / Exemple IndicoI2 avec moteur / Esempio Sistema Indico I2 manovra a motore**

Descripción / Description Description / Descrizione	Código / Code Code / Codice	Cantidad / Quantity Quantité / Quantità
<b>Tubo ranurado galvanizado / Galvanized round tube with ogive / Tube rond à gorge galvanisé / Rullo con ogiva</b>	<b>8003-23</b>	4 m
<b>Casquillo 70 mm ranurado de aluminio para punto, espiga redonda 12x20 mm / Round cap of 70 mm with round pivot of 12x20 mm in aluminum</b> <i>Embout mâle côté opposé, sortie ronde 12x20 mm, en aluminium / Calotta con ogiva Ø 70 mm alluminio con perno Ø 12x20 mm</i>	<b>8002-38</b>	1
<b>Juego anclaje inyeccion caset sin espiga / Set of injection brackets without round pivot</b> <i>Jeu de supports injection sans téton type cassette / Set supporti in pressofusione senza perno</i>	<b>8004-176</b>	1
<b>Juego brazo curvo I2, con semi-tensión (1,20 m) / Set of curved arms I2, with semi-tension (1,20 m)</b> <i>Jeu bras courbé I2, avec ressort de semi-tension (1,20 m) / Kit bracci curvi I2 con molla semi-tensione (1,20 m)</i>	<b>8006-380</b>	1
<b>Perfil Bambu 2 / Bambu2 profile / Profil Bambu2 / Profilo terminale Bambu 2</b>	<b>8005-304</b>	4 m
<b>Juego de tapas perfil Bambu2 / Set of caps for Bambu2 profile / Jeu d'embouts pour profil Bambu2 / Kit tappi profilo terminale Bambu 2</b>	<b>8005-312</b>	1
<b>Motor Logos 10 / Logos 10 Motor / Moteur Logos 10 / Motore Logos 10</b>	<b>6005-96</b>	1
<b>Acople para eje de 70 mm con ogiva / Adapter for 70 mm tube with ogive / Accouplement pour axe de 70 mm ogiva / Adattatore per rullo ogiva Ø 70 mm</b>	<b>6007-14</b>	1
<b>Emisor 1 canal Cronos / Cronos 1 remote control / Emetteur 1 canal Cronos / Telecomando a 1 canale Cronos</b>	<b>6009-118</b>	1
<b>Soporte obra y toldo serie 50 / 50 series bracket (built-in and awnings) / Support traditionnel et store serie 50 / Supporto motore con perno quadro 10 mm</b>	<b>6008-3</b>	1

**Ejemplo IndicoI2 con máquina / Example for IndicoI2 with gear / Exemple IndicoI2 avec treuil / Esempio Sistema Indico I2 manovra ad argano**

Descripción / Description Description / Descrizione	Código / Code Code / Codice	Cantidad / Quantity Quantité / Quantità
<b>Máquina Ciclon 1/7 cáncamo 90 mm acero zincado, roscada</b> / <i>Cyclon gear 1/7 90 mm eye, zinc steel, rolled</i> <i>Treuil Cyclon 1/7 anneau 90 mm acier zingué, vissé / Arganello Ciclon 1/7 occhiolo L90 mm, fori filettati</i>	<b>8001-185</b>	1
<b>Tubo ranurado galvanizado</b> / <i>Galvanized round tube with ogive</i> / <i>Tube rond à gorge galvanisé / Rullo con ogiva</i>	<b>8003-23</b>	4 m
<b>Casquillo 70 mm ranurado de aluminio para máquina, espiga cuadrada 13x33 mm</b> / <i>Driving round cap of 70 mm with square pivot of 13x33 mm in aluminum</i> <i>Embout mâle côté manoeuvre, sortie carrée 13x33 mm, en aluminium / Calotta con ogiva Ø 70 mm alluminio con perno quadro 13x33 mm</i>	<b>8002-28</b>	1
<b>Casquillo 70 mm ranurado de aluminio para punto, espiga redonda 12x20 mm</b> / <i>Round cap of 70 mm with round pivot of 12x20 mm in aluminum</i> <i>Embout mâle côté opposé, sortie ronde 12x20 mm, en aluminium / Calotta con ogiva Ø 70 mm alluminio con perno Ø 12x20 mm</i>	<b>8002-38</b>	1
<b>Juego anclaje inyeccion caset sin espiga</b> / <i>Set of injection brackets without round pivot</i> <i>Jeu de supports injection sans téton type cassette / Set supporti in pressofusione senza perno</i>	<b>8004-176</b>	1
<b>Juego brazo curvo I2, con semi-tensión (1,20 m)</b> / <i>Set of curved arms I2, with semi-tension (1,20 m)</i> <i>Jeu bras courbé I2, avec ressort de semi-tension (1,20 m) / Kit bracci curvi I2 con molla semi-tensione (1,20 m)</i>	<b>8006-380</b>	1
<b>Perfil Bambu 2</b> / <i>Bambu2 profile / Profil Bambu2 / Profilo terminale Bambu 2</i>	<b>8005-304</b>	4 m
<b>Juego de tapas perfil Bambu2</b> / <i>Set of caps for Bambu2 profile / Jeu d'embouts pour profil Bambu2 / Kit tappi profilo Bambu2</i>	<b>8005-312</b>	1
<b>Manivela extra lacada gancho zincado (1,20 m)</b> / <i>Lacquered handcrank, zinc plated steel hook (1,20 m)</i> <i>Manivelle laquée crochet zingué (1,20 m) / Asta verniciata gancio zinc (1,20 m)</i>	<b>8009-9</b>	1
<b>Pinza sujeta manivela de poliamida</b> / <i>Polyamide handle lock / Bloqueur de manivelle en polyamide / Ferma asta plastica</i>	<b>7010-39</b>	1

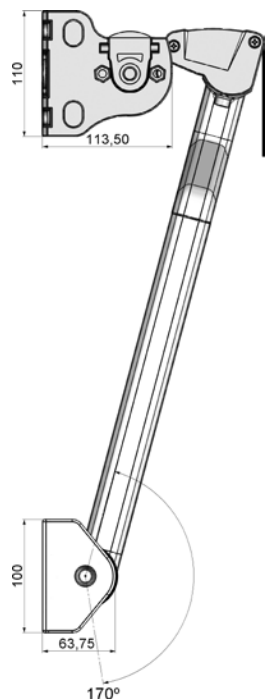

### Inclinación máxima

Maximum inclination

Inclinaison maximale

Inclinazione massima

El sistema Indico tiene tres modelos:

**Sistema I1: Brazo sin tensión.**

**Sistema I2: Brazo de semitensión (la tensión está en el soporte).**

**Sistema I3: Brazo de tensión (la tensión está en el brazo mediante un muelle interno).**

There are three options for the arms in the Indico System:

I1 System: The arm has no tension.

I2 System: The arm has medium tension (it is within the support).

I3 System: Arm with tension (it is in the arm through an inner spring).

Le système Indico a trois modèles:

Système I1: Bras sans tension.

Système I2: Bras de semitension (la tension est dans le support).

Système I3: Bras tension (la tension est dans le bras grâce au ressort interne).

Del sistema Indico sono disponibili 3 modelli:

Sistema Indico I1: Bracci senza tensione (funzionamento per caduta).

Sistema Indico I2: Bracci semi-tensione (sistema di tensione nel supporto).

Sistema Indico I3: Bracci a tensione (molla di tensione integrata nel braccio).

### Motorización

Motorization

Motorisation

Motorizzazione

Salida en metros Arms projection in meters Projection en mètres Sporgenza in metri	Línea en metros / Width in meters / Ligne en mètres / Larghezza in metri				
	3,00	4,00	5,00	6,00	7,00
	Número de brazos / Number of arms / Nombre de bras / Numero di bracci				
1,00	2		2		3
1,50	LOGOS 10 / GM 12		LOGOS 15 / GM 15		LOGOS 20 / GM 20
	LOGOS 10 / GM 12		LOGOS 15 / GM 15		LOGOS 20 / GM 20

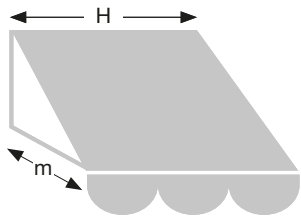

1,50	2,00	3,00	4,50	5,00	6,00	H m
3	3	3	3	3	3	1,50
3	3	3	3	3	3	1,40
3	3	3	3	3	3	1,30
3	3	3	3	3	3	1,20
3	3	3	3	3	3	1,10
3	3	3	3	3	3	1,00
3	3	3	3	3	3	0,90
3	3	3	3	3	3	0,80
3	3	3	3	3	3	0,70

## Indicol1

\* NOTA: Las clases expuestas han sido obtenidas según las condiciones de ensayos descritos en los E.I.T. de Gaviota Simbac.

\* NOTE: The different classes have been fulfilled according to the described conditions at Gaviota Simbac initial tests.

\* NOTE: Le classement exposé a été obtenu suivant les conditions d'essais indiquées sur le manuel technique E.I.T. de Gaviota Simbac.

\* NOTA: Le classi esposte, sono state ottenute secondo le condizioni di prova descritte nel manuale E.I.T. di Gaviota Simbac.

- Clase 0 / Class 0 / Clase 0 / Classe 0**  
No cumple homologación / It does not fulfil the requirements / Il n'est pas homologué / Non è prevista omologazione.
- Clase 1 / Class 1 / Clase 1 / Classe 1**
- Clase 2 / Class 2 / Clase 2 / Classe 2**
- Clase 3 / Class 3 / Clase 3 / Classe 3**
- IM Imposibilidad de montaje / Impossible to assemble / Impossibilité de montage / Impossibile il montaggio**

1,50	2,00	3,00	4,50	5,00	6,00	H m
3 <sup>3</sup>	3 <sup>3</sup>	3 <sup>3</sup>	3 <sup>3</sup>	3 <sup>3</sup>	3 <sup>3</sup>	1,50
3 <sup>3</sup>	3 <sup>3</sup>	3 <sup>3</sup>	3 <sup>3</sup>	3 <sup>3</sup>	3 <sup>3</sup>	1,40
3 <sup>3</sup>	3 <sup>3</sup>	3 <sup>3</sup>	3 <sup>3</sup>	3 <sup>3</sup>	3 <sup>3</sup>	1,30
3	3	3	3	3	3	1,20
3	3	3	3	3	3	1,10
3	3	3	3	3	3	1,00
3	3	3	3	3	3	0,90
3	3	3	3	3	3	0,80
3 <sup>2</sup>	3 <sup>2</sup>	3 <sup>2</sup>	3 <sup>2</sup>	3 <sup>2</sup>	3 <sup>2</sup>	0,70
3 <sup>2</sup>	3 <sup>2</sup>	3 <sup>2</sup>	3 <sup>2</sup>	3 <sup>2</sup>	3 <sup>2</sup>	0,60

<sup>2</sup> Sólo aplica al sistema I2

<sup>2</sup> It only applies to I2 system

<sup>2</sup> Seulement pour système I2

<sup>2</sup> Si applica al solo sistema I2

<sup>3</sup> Sólo aplica al sistema I3

<sup>3</sup> It only applies to I3 system

<sup>3</sup> Seulement pour système I3

<sup>3</sup> Si applica al solo sistema I3

Indicol2-I3 







Descripción / Description Description / Descrizione	Código / Code Code / Codice	L / m	Color / Colour Couleur / Colore
<b>Brazo curvo I1, sin tensión.</b> <i>Curved arm I1, without tension.</i> <i>Bras courbé I1, sans tension.</i> <i>Braccio curvo I1, senza molla.</i>	8006-2	0,70	Blanco / White / Blanc / Bianco
	8006-182	0,70	Negro / Black / Noir / Nero
	8006-227	0,70	Plata / Silver / Argent / Argento
	8006-218	0,70	Bronce / Bronze / Bronzo
	8006-147	0,70	Burdeos / Dark red / Bordeaux
	8006-146	0,70	Verde / Green / Vert
	8006-236*	0,70	Beige
<b>Brazo curvo I1, sin tensión.</b> <i>Curved arm I1, without tension.</i> <i>Bras courbé I1, sans tension.</i> <i>Braccio curvo I1, senza molla.</i>	8006-8	0,80	Blanco / White / Blanc / Bianco
	8006-183	0,80	Negro / Black / Noir / Nero
	8006-228	0,80	Plata / Silver / Argent / Argento
	8006-219	0,80	Bronce / Bronze / Bronzo
	8006-149	0,80	Burdeos / Dark red / Bordeaux
	8006-148	0,80	Verde / Green / Vert
	8006-237*	0,80	Beige
<b>Brazo curvo I1, sin tensión.</b> <i>Curved arm I1, without tension.</i> <i>Bras courbé I1, sans tension.</i> <i>Braccio curvo I1, senza molla.</i>	8006-14	0,90	Blanco / White / Blanc / Bianco
	8006-184	0,90	Negro / Black / Noir / Nero
	8006-229	0,90	Plata / Silver / Argent / Argento
	8006-220	0,90	Bronce / Bronze / Bronzo
	8006-151	0,90	Burdeos / Dark red / Bordeaux
	8006-150	0,90	Verde / Green / Vert
	8006-238*	0,90	Beige
<b>Brazo curvo I1, sin tensión.</b> <i>Curved arm I1, without tension.</i> <i>Bras courbé I1, sans tension.</i> <i>Braccio curvo I1, senza molla.</i>	8006-20	1,00	Blanco / White / Blanc / Bianco
	8006-185	1,00	Negro / Black / Noir / Nero
	8006-230	1,00	Plata / Silver / Argent / Argento
	8006-221	1,00	Bronce / Bronze / Bronzo
	8006-153	1,00	Burdeos / Dark red / Bordeaux
	8006-152	1,00	Verde / Green / Vert
	8006-239*	1,00	Beige





Descripción / Description Description / Descrizione	Código / Code Code / Codice	L / m	Color / Colour Couleur / Colore
<b>Brazo curvo I1, sin tensión.</b> <i>Curved arm I1, without tension.</i> <i>Bras courbé I1, sans tension.</i> <i>Braccio curvo I1, senza molla.</i>	8006-26	1,10	Blanco / White / Blanc / Bianco
	8006-186	1,10	Negro / Black / Noir / Nero
	8006-231	1,10	Plata / Silver / Argent / Argento
	8006-222	1,10	Bronce / Bronze / Bronzo
	8006-155	1,10	Burdeos / Dark red / Bordeaux
	8006-154	1,10	Verde / Green / Vert
	8006-240*	1,10	Beige
<b>Brazo curvo I1, sin tensión.</b> <i>Curved arm I1, without tension.</i> <i>Bras courbé I1, sans tension.</i> <i>Braccio curvo I1, senza molla.</i>	8006-32	1,20	Blanco / White / Blanc / Bianco
	8006-187	1,20	Negro / Black / Noir / Nero
	8006-232	1,20	Plata / Silver / Argent / Argento
	8006-223	1,20	Bronce / Bronze / Bronzo
	8006-157	1,20	Burdeos / Dark red / Bordeaux
	8006-156	1,20	Verde / Green / Vert
	8006-241*	1,20	Beige
<b>Brazo curvo I1, sin tensión.</b> <i>Curved arm I1, without tension.</i> <i>Bras courbé I1, sans tension.</i> <i>Braccio curvo I1, senza molla.</i>	8006-38	1,30	Blanco / White / Blanc / Bianco
	8006-492	1,30	Negro / Black / Noir / Nero
	8006-233	1,30	Plata / Silver / Argent / Argento
	8006-224	1,30	Bronce / Bronze / Bronzo
	8006-494	1,30	Burdeos / Dark red / Bordeaux
	8006-493	1,30	Verde / Green / Vert
	8006-242*	1,30	Beige
<b>Brazo curvo I1, sin tensión.</b> <i>Curved arm I1, without tension.</i> <i>Bras courbé I1, sans tension.</i> <i>Braccio curvo I1, senza molla.</i>	8006-44	1,40	Blanco / White / Blanc / Bianco
	8006-188	1,40	Negro / Black / Noir / Nero
	8006-234	1,40	Plata / Silver / Argent / Argento
	8006-225	1,40	Bronce / Bronze / Bronzo
	8006-159	1,40	Burdeos / Dark red / Bordeaux
	8006-158	1,40	Verde / Green / Vert
	8006-243*	1,40	Beige

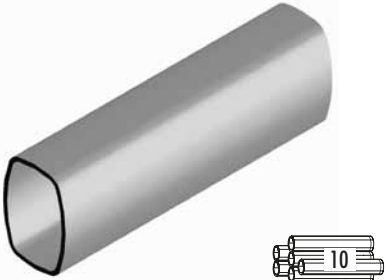

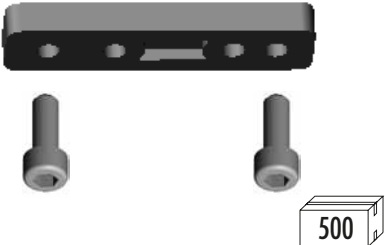
	<b>Descripción / Description Description / Descrizione</b>	<b>Código / Code Code / Codice</b>	<b>L / m</b>	<b>Color / Colour Couleur / Colore</b>
	<p><b>Brazo curvo I1, sin tensión.</b>  <i>Curved arm I1, without tension.</i>  <i>Bras courbé I1, sans tension.</i>  <i>Braccio curvo I1, senza molla.</i></p>	<p>8006-50 8006-189 8006-235 8006-226 8006-161 8006-160 8006-244*</p>	<p>1,50 1,50 1,50 1,50 1,50 1,50 1,50</p>	<p>Blanco / White / Blanc / Bianco Negro / Black / Noir / Nero Plata / Silver / Argent / Argento Bronce / Bronze / Bronzo Burdeos / Dark red / Bordeaux Verde / Green / Vert Beige</p>
	<p><b>Perfil aluminio I1, brazo curvo.</b>  <i>Aluminum profile I1, curved arm.</i>  <i>Profil aluminium I1, bras courbé.</i>  <i>Profilo in alluminio per braccio curvo I1.</i></p>	<p>8006-569 8006-560 8006-564 8006-568 8006-566 8006-563 8006-562 8006-565*</p>	<p>5,8 6 6 6 6 6 6 6</p>	<p>Blanco / White / Blanc / Bianco Blanco / White / Blanc / Bianco Negro / Black / Noir / Nero Plata / Silver / Argent / Argento Bronce / Bronze / Bronzo Burdeos / Dark red / Bordeaux Verde / Green / Vert Beige</p>
	<p><b>Juego de codos terminal faldón I1, 2 taladros brazo curvo.</b>  <i>Set of elbow joints I1, 2 holes for curved arms.</i>  <i>Jeu de coudes I1, 2 trous.</i>  <i>Kit terminali lato barra prof. braccio curvo I1.</i></p>	<p>8006-579 8006-581 8006-580 8006-582 8006-584 8006-583 8006-585*</p>		<p>Blanco / White / Blanc / Bianco Negro / Black / Noir / Nero Plata / Silver / Argent / Argento Bronce / Bronze / Bronzo Burdeos / Dark red / Bordeaux Verde / Green / Vert Beige</p>
	<p><b>Regleta zamak 4 taladros con tornillos.</b>  <i>4 bolt plate with screws.</i>  <i>Réglette de fixation en zamak 4 trous avec vis.</i>  <i>Kit piastrina 4 fori con viti.</i></p>	<p>8013-16</p>		<p>Natural / Naturel</p>



20

**Descripción / Description  
Description / Descrizione**

**Conjunto terminal de pared I1, brazo curvo.**  
Terminal wall support I1, for curved arms.  
Terminale mur I1, bras courbé.  
Kit terminale a parete I1 braccio curvo.

**Código / Code  
Code / Codice**

8006-587  
8006-589  
8006-588  
8006-590  
8006-592  
8006-591  
8006-593\*

**L / m**

**Color / Colour  
Couleur / Colore**

Blanco / White / Blanc / Bianco  
Negro / Black / Noir / Nero  
Plata / Silver / Argent / Argento  
Bronce / Bronze / Bronzo  
Burdeos / Dark red / Bordeaux  
Verde / Green / Vert  
Beige

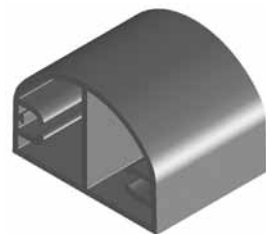

20

**Separador pared para brazo curvo I1.**

Adjusting support for curved arm I1.  
Séparateur mur pour bras courbé I1.  
Supporto di spessoramento braccio curvo I1.

8006-571  
8006-573

Blanco / White / Blanc / Bianco  
Negro / Black / Noir / Nero



Descripción / Description Description / Descrizione	Código / Code Code / Codice	L / m	Color / Colour Couleur / Colore
<b>Juego brazo curvo I2, con semi-tensión.</b> Set of curved arms I2, with semi-tension. Jeu bras courbé I2, avec ressort de semi-tension. Kit bracci curvi I2, con molla semi-tensione.	8006-512	0,60	Blanco / White / Blanc / Bianco
	8006-514	0,60	Negro / Black / Noir / Nero
	8006-513	0,60	Plata / Silver / Argent / Argento
	8006-515	0,60	Bronce / Bronze / Bronzo
	8006-518	0,60	Burdeos / Dark red / Bordeaux
	8006-517	0,60	Verde / Green / Vert
	8006-519*	0,60	Beige
<b>Juego brazo curvo I2, con semi-tensión.</b> Set of curved arms I2, with semi-tension. Jeu bras courbé I2, avec ressort de semi-tension. Kit bracci curvi I2, con molla semi-tensione.	8006-340	0,70	Blanco / White / Blanc / Bianco
	8006-342	0,70	Negro / Black / Noir / Nero
	8006-341	0,70	Plata / Silver / Argent / Argento
	8006-343	0,70	Bronce / Bronze / Bronzo
	8006-346	0,70	Burdeos / Dark red / Bordeaux
	8006-345	0,70	Verde / Green / Vert
	8006-347*	0,70	Beige
<b>Juego brazo curvo I2, con semi-tensión.</b> Set of curved arms I2, with semi-tension. Jeu bras courbé I2, avec ressort de semi-tension. Kit bracci curvi I2, con molla semi-tensione.	8006-348	0,80	Blanco / White / Blanc / Bianco
	8006-350	0,80	Negro / Black / Noir / Nero
	8006-349	0,80	Plata / Silver / Argent / Argento
	8006-351	0,80	Bronce / Bronze / Bronzo
	8006-354	0,80	Burdeos / Dark red / Bordeaux
	8006-353	0,80	Verde / Green / Vert
	8006-355*	0,80	Beige
<b>Juego brazo curvo I2, con semi-tensión.</b> Set of curved arms I2, with semi-tension. Jeu bras courbé I2, avec ressort de semi-tension. Kit bracci curvi I2, con molla semi-tensione.	8006-356	0,90	Blanco / White / Blanc / Bianco
	8006-358	0,90	Negro / Black / Noir / Nero
	8006-357	0,90	Plata / Silver / Argent / Argento
	8006-359	0,90	Bronce / Bronze / Bronzo
	8006-362	0,90	Burdeos / Dark red / Bordeaux
	8006-361	0,90	Verde / Green / Vert
	8006-363*	0,90	Beige





Descripción / Description Description / Descrizione	Código / Code Code / Codice	L / m	Color / Colour Couleur / Colore
<b>Juego brazo curvo I2, con semi-tensión.</b> <i>Set of curved arms I2, with semi-tension.</i> <i>Jeu bras courbé I2, avec ressort de semi-tension.</i> <i>Kit bracci curvi I2, con molla semi-tensione.</i>	8006-364	1,00	Blanco / White / Blanc / Bianco
	8006-366	1,00	Negro / Black / Noir / Nero
	8006-365	1,00	Plata / Silver / Argent / Argento
	8006-367	1,00	Bronce / Bronze / Bronzo
	8006-370	1,00	Burdeos / Dark red / Bordeaux
	8006-369	1,00	Verde / Green / Vert
	8006-371*	1,00	Beige
<b>Juego brazo curvo I2, con semi-tensión.</b> <i>Set of curved arms I2, with semi-tension.</i> <i>Jeu bras courbé I2, avec ressort de semi-tension.</i> <i>Kit bracci curvi I2, con molla semi-tensione.</i>	8006-372	1,10	Blanco / White / Blanc / Bianco
	8006-374	1,10	Negro / Black / Noir / Nero
	8006-373	1,10	Plata / Silver / Argent / Argento
	8006-375	1,10	Bronce / Bronze / Bronzo
	8006-378	1,10	Burdeos / Dark red / Bordeaux
	8006-377	1,10	Verde / Green / Vert
	8006-379*	1,10	Beige
<b>Juego brazo curvo I2, con semi-tensión.</b> <i>Set of curved arms I2, with semi-tension.</i> <i>Jeu bras courbé I2, avec ressort de semi-tension.</i> <i>Kit bracci curvi I2, con molla semi-tensione.</i>	8006-380	1,20	Blanco / White / Blanc / Bianco
	8006-382	1,20	Negro / Black / Noir / Nero
	8006-381	1,20	Plata / Silver / Argent / Argento
	8006-383	1,20	Bronce / Bronze / Bronzo
	8006-386	1,20	Burdeos / Dark red / Bordeaux
	8006-385	1,20	Verde / Green / Vert
	8006-387*	1,20	Beige



Descripción / Description Description / Descrizione	Código / Code Code / Codice	L / m	Color / Colour Couleur / Colore
<b>Juego brazo curvo I3, con tensión.</b> <i>Set of curved arms I3, with tension.</i> <i>Jeu bras courbé I3, avec ressort de tension.</i> <i>Kit bracci curvi I3, con molla tensione.</i>	8006-428	0,80	Blanco / White / Blanc / Bianco
	8006-430	0,80	Negro / Black / Noir / Nero
	8006-429	0,80	Plata / Silver / Argent / Argento
	8006-431	0,80	Bronce / Bronze / Bronzo
	8006-434	0,80	Burdeos / Dark red / Bordeaux
	8006-433	0,80	Verde / Green / Vert
	8006-435*	0,80	Beige
<b>Juego brazo curvo I3, con tensión.</b> <i>Set of curved arms I3, with tension.</i> <i>Jeu bras courbé I3, avec ressort de tension.</i> <i>Kit bracci curvi I3, con molla tensione.</i>	8006-436	0,90	Blanco / White / Blanc / Bianco
	8006-438	0,90	Negro / Black / Noir / Nero
	8006-437	0,90	Plata / Silver / Argent / Argento
	8006-439	0,90	Bronce / Bronze / Bronzo
	8006-442	0,90	Burdeos / Dark red / Bordeaux
	8006-441	0,90	Verde / Green / Vert
	8006-443*	0,90	Beige
<b>Juego brazo curvo I3, con tensión.</b> <i>Set of curved arms I3, with tension.</i> <i>Jeu bras courbé I3, avec ressort de tension.</i> <i>Kit bracci curvi I3, con molla tensione.</i>	8006-444	1,00	Blanco / White / Blanc / Bianco
	8006-446	1,00	Negro / Black / Noir / Nero
	8006-445	1,00	Plata / Silver / Argent / Argento
	8006-447	1,00	Bronce / Bronze / Bronzo
	8006-450	1,00	Burdeos / Dark red / Bordeaux
	8006-449	1,00	Verde / Green / Vert
	8006-451*	1,00	Beige
<b>Juego brazo curvo I3, con tensión.</b> <i>Set of curved arms I3, with tension.</i> <i>Jeu bras courbé I3, avec ressort de tension.</i> <i>Kit bracci curvi I3, con molla tensione.</i>	8006-452	1,10	Blanco / White / Blanc / Bianco
	8006-454	1,10	Negro / Black / Noir / Nero
	8006-453	1,10	Plata / Silver / Argent / Argento
	8006-455	1,10	Bronce / Bronze / Bronzo
	8006-458	1,10	Burdeos / Dark red / Bordeaux
	8006-457	1,10	Verde / Green / Vert
	8006-459*	1,10	Beige





Descripción / Description Description / Descrizione	Código / Code Code / Codice	L / m	Color / Colour Couleur / Colore
<b>Juego brazo curvo I3, con tensión.</b> <i>Set of curved arms I3, with tension.</i> <i>Jeu bras courbé I3, avec ressort de tension.</i> <i>Kit bracci curvi I3, con molla tensione.</i>	8006-460	1,20	Blanco / White / Blanc / Bianco
	8006-462	1,20	Negro / Black / Noir / Nero
	8006-461	1,20	Plata / Silver / Argent / Argento
	8006-463	1,20	Bronce / Bronze / Bronzo
	8006-466	1,20	Burdeos / Dark red / Bordeaux
	8006-465	1,20	Verde / Green / Vert
	8006-467*	1,20	Beige
<b>Juego brazo curvo I3, con tensión.</b> <i>Set of curved arms I3, with tension.</i> <i>Jeu bras courbé I3, avec ressort de tension.</i> <i>Kit bracci curvi I3, con molla tensione.</i>	8006-468	1,30	Blanco / White / Blanc / Bianco
	8006-470	1,30	Negro / Black / Noir / Nero
	8006-469	1,30	Plata / Silver / Argent / Argento
	8006-471	1,30	Bronce / Bronze / Bronzo
	8006-474	1,30	Burdeos / Dark red / Bordeaux
	8006-473	1,30	Verde / Green / Vert
	8006-475*	1,30	Beige
<b>Juego brazo curvo I3, con tensión.</b> <i>Set of curved arms I3, with tension.</i> <i>Jeu bras courbé I3, avec ressort de tension.</i> <i>Kit bracci curvi I3, con molla tensione.</i>	8006-476	1,40	Blanco / White / Blanc / Bianco
	8006-478	1,40	Negro / Black / Noir / Nero
	8006-477	1,40	Plata / Silver / Argent / Argento
	8006-479	1,40	Bronce / Bronze / Bronzo
	8006-482	1,40	Burdeos / Dark red / Bordeaux
	8006-481	1,40	Verde / Green / Vert
	8006-483*	1,40	Beige
<b>Juego brazo curvo I3, con tensión.</b> <i>Set of curved arms I3, with tension.</i> <i>Jeu bras courbé I3, avec ressort de tension.</i> <i>Kit bracci curvi I3, con molla tensione.</i>	8006-484	1,50	Blanco / White / Blanc / Bianco
	8006-486	1,50	Negro / Black / Noir / Nero
	8006-485	1,50	Plata / Silver / Argent / Argento
	8006-487	1,50	Bronce / Bronze / Bronzo
	8006-490	1,50	Burdeos / Dark red / Bordeaux
	8006-489	1,50	Verde / Green / Vert
	8006-491*	1,50	Beige





# Indicol2 - Indicol3

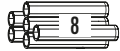

## Perfil aluminio Indicol2 - Indicol3.

*Aluminum profile  
Indicol2 - Indicol3.*

*Profil aluminium  
Indicol2 - Indicol3.*

*Profilo alluminio  
braccio curvo Indico I2 - Indico I3.*

**Descripción / Description  
Description / Descrizione**

**Código / Code  
Code / Codice**

**L / m**

**Color / Colour  
Couleur / Colore**

8006-505

5,8

Blanco / White / Blanc / Bianco

8006-412

6

Blanco / White / Blanc / Bianco

8006-414

6

Negro / Black / Noir / Nero

8006-413

6

Plata / Silver / Argent / Argento

8006-415

6

Bronce / Bronze / Bronzo

8006-418

6

Burdeos / Dark red / Bordeaux

8006-417

6

Verde / Green / Vert

8006-419\*

6

Beige

## Juego codos Indicol2 - Indicol3, inyección.

*Injection elbow joints  
Indicol2 - Indicol3.*

*Jeu de coudes Indicol2 - Indicol3, injection.*

*Kit terminali per braccio curvo Indico I2 - Indico I3.*



8006-404

Blanco / White / Blanc / Bianco

8006-406

Negro / Black / Noir / Nero

8006-405

Plata / Silver / Argent / Argento

8006-407

Bronce / Bronze / Bronzo

8006-410

Burdeos / Dark red / Bordeaux

8006-409

Verde / Green / Vert

8006-411\*

Beige

## Juego de soporte Indicol2, con semi-tensión.

*Set of wall supports  
Indicol2, with semi-tension.*

*Jeu support Indicol2,  
avec ressort de semi-tension.*

*Kit supporti Indico I2, molla semi-tensione.*

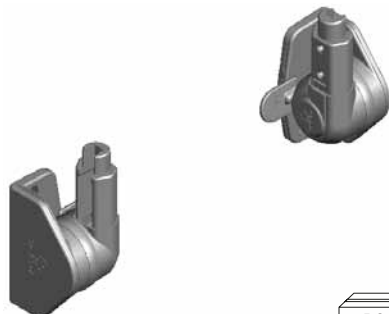

8006-388

Blanco / White / Blanc / Bianco

8006-390

Negro / Black / Noir / Nero

8006-389

Plata / Silver / Argent / Argento

8006-391

Bronce / Bronze / Bronzo

8006-394

Burdeos / Dark red / Bordeaux



8006-393

Verde / Green / Vert

8006-395\*

Beige

## Indicol2 - Indico I3

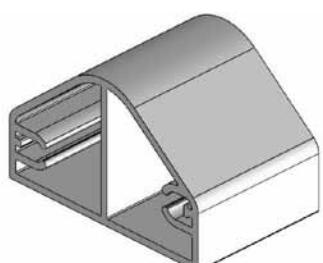
		Descripción / Description Description / Descrizione	Código / Code Code / Codice	L / m	Color / Colour Couleur / Colore
	<b>Juego de soporte Indicol3, con tensión.</b> <i>Set of brackets Indicol3, with tension.</i> <i>Platines de bras Indicol3, avec ressort.</i> <i>Kit supporti Indico I3, con molla tensione.</i>		8006-529	0,70	Blanco / White / Blanc / Bianco
			8006-531	0,70	Negro / Black / Noir / Nero
			8006-530	0,70	Plata / Silver / Argent / Argento
			8006-532	0,70	Bronce / Bronze / Bronzo
			8006-534	0,70	Burdeos / Dark red / Bordeaux
			8006-533	0,70	Verde / Green / Vert
			8006-535*	0,70	Beige
		<b>Juego de soporte Indicol3, con tensión.</b>		8006-420	0,80 m
		8006-422	0,90 m	Negro / Black / Noir / Nero	
<i>Set of brackets Indicol3, with tension.</i>		8006-421	1,00 m	Plata / Silver / Argent / Argento	
<i>Platines de bras Indicol3, avec ressort.</i>		8006-423	1,10 m	Bronce / Bronze / Bronzo	
<i>Kit supporti Indico I3, con molla tensione.</i>		8006-426	1,20 m	Burdeos / Dark red / Bordeaux	
		8006-425	1,30 m	Verde / Green / Vert	
		8006-427*	1,40 m	Beige	
			1,50 m		
	<b>Separador pared para brazo curvo I2-I3.</b> <i>Adjusting support for curved arm I2-I3.</i> <i>Séparateur mur pour bras courbé I2-I3.</i> <i>Supporto di spessore braccio curvo I2-I3.</i>		8006-600		Blanco / White / Blanc / Bianco
			8006-602		Negro / Black / Noir / Nero
